

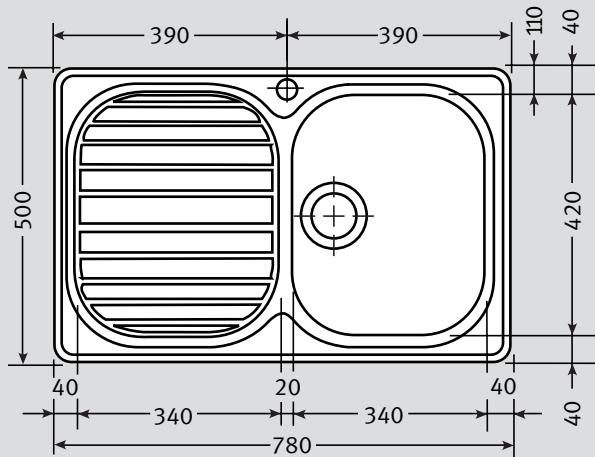

CPX 611 780 Specifications

- **Unique Double-Edge profile and corner radii.** Sink lies completely flat on worktop and cloths will not snag on corners
- **Unique Drainer Design**
- **Retentioned Drainer**
- **90mm Waste with Basket Strainer Waste.** Capable of adaptation to take Waste Disposal Unit
- **3 colours of bespoke accessories available**
- **Classic Compact Franke design**

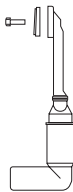
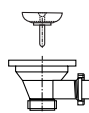

Material:	304 Austenitic 18/10 Stainless Steel	Waste:	1 x Lira 90mm Basket Strainer Waste	Overflow:	
Application:	Inset or undermount				
Bowl size:	340 x 420 x 175 (Bowl welded to frame)				
Drainer Format:	Left or right hand drainer available				
Cut-out size:	764 x 484 (cr=20)				
Colour:	Silk Stainless Steel	Accessories available:			
Seal:	Factory Fitted Polyurethane Seal				
Insulation:	Grey Dynaphon for heat and sound	Food Preparation Platter Mahogany	Food Preparation Platter Hygenia	Drainer Tray Available in White, Almond, Brown or Black	
Heat Resistance:	Up to 300°C				
Earthing Point:	Located at end of clip rail	Drainer Basket/Plate Rack Available in White, Almond, Brown or Black	Drainer Basket Stainless Steel		
Cabinet size:		Sink Profile: Double Edge	Fixing Clips: 'S' rail		
					
Suggested Plumbing Kit: 1 part		Taps: Any Franke tap can be utilised with this model*.			
		*Ceramic disc taps in certain installations or where there is a low head of water (below 4 metres) may not provide adequate flow rates. You are advised to check with your supplier.			
		Some taps may need bracing to avoid flexing of the sink ledge.			

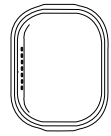
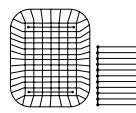
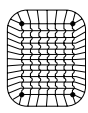
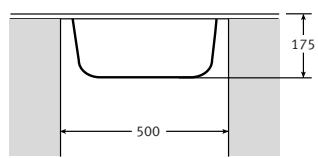
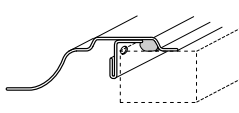
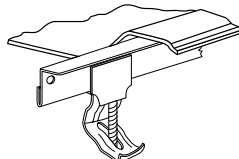
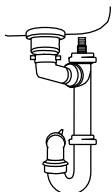
Guarantee: Franke sinks are guaranteed for 25 years against manufacturing defect. Franke taps are guaranteed against defective materials and workmanship for 1 year in relation to coatings and finishes, and 5 years in relation to moving parts. Franke will replace (and where appropriate repair) defective sinks. In relation to taps, Franke will where appropriate provide replacement parts for your taps or replace your taps. Any associated or ancillary costs to be incurred by you as a result of replacement of Franke sinks and taps under this guarantee shall in all cases be previously approved by Franke UK Limited.

This guarantee is in addition to and does not affect your statutory rights.