

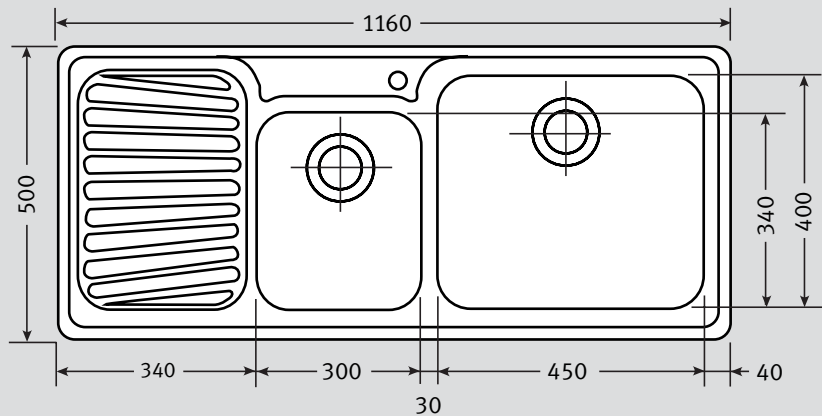

# INX 621 Specifications

- Modern functional design
- Extra large multi-purpose bowl
- Provides useful large second bowl
- 2 x 90mm Wastes with Basket Strainer Waste on all bowls. Capable of adaptation to take Waste Disposal Unit
- Wastes at rear of bowls
- 3 colours of bespoke accessories available



<b>Material:</b>	304 Austenitic 18/10 Stainless Steel	<b>Waste:</b>	1 x Lira 90mm Basket Strainer Waste with overflow 1 x Lira 90mm Basket Strainer Waste	<b>Overflow:</b>	
<b>Application:</b>	Inset	<b>Bowl size:</b>	450 x 400 x 190 } Bowls welded to frame 300 x 340 x 170 }	<b>Accessories available:</b>	
<b>Drainer Format:</b>	Left or right hand drainer available	<b>Food Preparation Platter:</b>	Mahogany	<b>Drainer Basket:</b>	Available in White, Almond or Brown
<b>Cut-out size:</b>	1140 x 480 (cr=20)	<b>Insulation:</b>	Factory fitted black pads		
<b>Colour:</b>	Silk Stainless Steel	<b>Heat Resistance:</b>	Up to 300°C		
<b>Seal:</b>	Sealing strip supplied	<b>Earthing Point:</b>	Utilise clip rail slots		

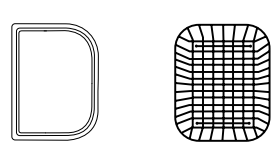
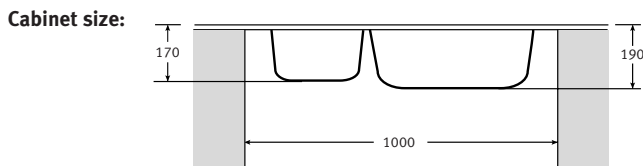

**Sink Profile:** Folded edge

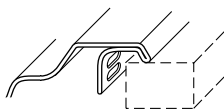

**Fixing Clips:**

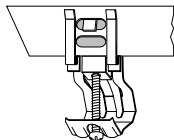

**Suggested Plumbing Kit:** 2 part

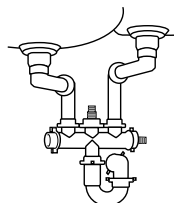

**Taps:** Any Franke tap can be utilised with this model\* (owing to the profile of this model we do not recommend Olympus, Dolphin or Franke Triflow taps with these sink).

\*Ceramic disc taps in certain installations or where there is a low head of water (below 4 metres) may not provide adequate flow rates. You are advised to check with your supplier.

Some taps may need bracing to avoid flexing of the sink ledge.

**Guarantee:** Franke sinks are guaranteed for 25 years against manufacturing defect. Franke taps are guaranteed against defective materials and workmanship for 1 year in relation to coatings and finishes, and 5 years in relation to moving parts. Franke will replace (and where appropriate repair) defective sinks. In relation to taps, Franke will where appropriate provide replacement parts for your taps or replace your taps. Any associated or ancillary costs to be incurred by you as a result of replacement of Franke sinks and taps under this guarantee shall in all cases be previously approved by Franke UK Limited.

This guarantee is in addition to and does not affect your statutory rights.