

Laser LSX 651 Specifications

- Unique fitting system
- Thin edge profile
- Ease of installation
- Modern sleek design
- Deep recessed drainer
- 2 x 90mm Wastes with Basket Strainer Wastes. Capable of adaptation to take Waste Disposal Unit
- Bespoke accessories available

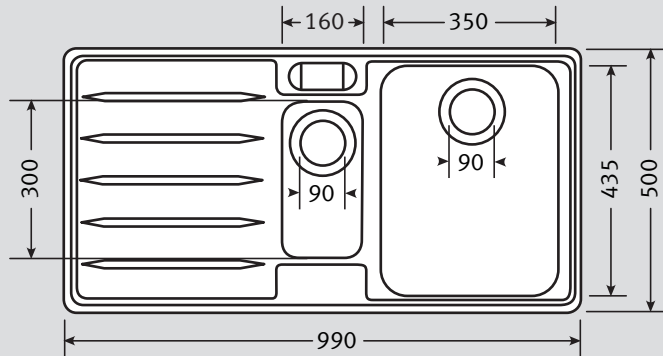

Material:	304 Austenitic 18/10 Stainless Steel
Application:	Inset
Bowl Size:	350 x 435 x 180 } Bowls welded to frame 160 x 300 x 130 }
Drainer Format:	Left or right handed drainer available
Cut-out Size:	977 x 487 (cr=10) Always use template
Colour:	Silk Finish Stainless Steel
Seal:	Apply locally
Insulation:	Grey Dynaphon for heat and sound
Heat Resistance:	Up to 300°C
Earthing Point:	N/A

Waste: 1 x Lira 90mm Basket Strainer Waste with overflow
1 x Lira 90mm Basket Strainer Waste

Overflow:

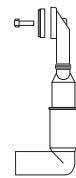
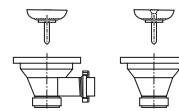

Accessories Available:

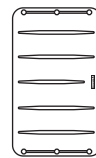

Sliding Glass Food Preparation Platter



Strainer Bowl
Stainless Steel

Cabinet Size:

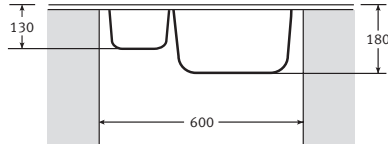

Fixing Clips: Patented Franke Slimfix® System

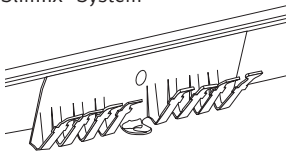

Suggested Plumbing Kit: 2 part

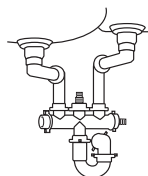

Taps: Any Franke tap can be utilised with this model*.

*Ceramic disc taps in certain installations or where there is a low head of water (below 4 metres) may not provide adequate flow rates. You are advised to check with your supplier.

Some taps may need bracing to avoid flexing of the sink ledge.

Guarantee: Franke sinks are guaranteed for 25 years against manufacturing defect. Franke taps are guaranteed against defective materials and workmanship for 1 year in relation to coatings and finishes, and 5 years in relation to moving parts. Franke will replace (and where appropriate repair) defective sinks. In relation to taps, Franke will where appropriate provide replacement parts for your taps or replace your taps. Any associated or ancillary costs to be incurred by you as a result of replacement of Franke sinks and taps under this guarantee shall in all cases be previously approved by Franke UK Limited.

This guarantee is in addition to and does not affect your statutory rights.