

Mythos MTG 651-100 Specifications

- Stylish modern minimalist design
- 25mm radii
- Jumbo bowl
- Glide and Slide accessories included
- 2 x 90mm Basket Strainer Wastes. Capable of adaptation to take a Waste Disposal Unit.

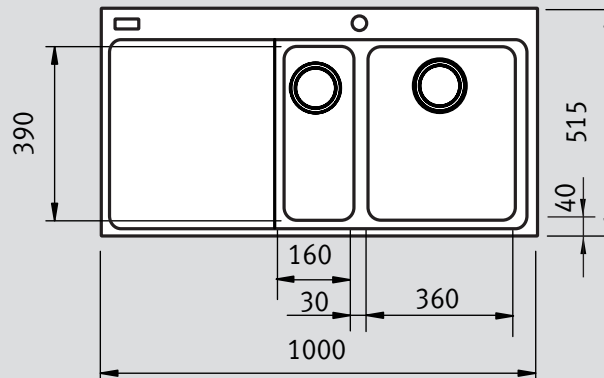

Material:	SilkSheen Fraganite
Application:	Inset
Bowl size:	360 x 390 x 200mm 160 x 390 x 140mm
Drainer Format:	Left or right hand drainer available
Cut-out size:	984 x 494mm (cr=10)
Colour:	Fragranite SilkSheen: Polar White & Graphite
Seal:	Apply sealant locally
Insulation:	Integral
Heat Resistance:	Up to 280°C
Earthing Point:	N/A

Waste: 2 x McAlpine 90mm Basket Strainer Wastes with overflow

Overflow:

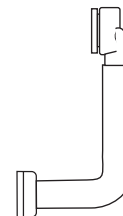
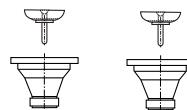

Accessories available:

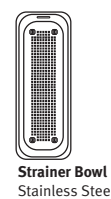
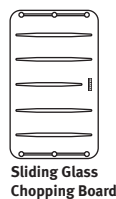

Cabinet size:

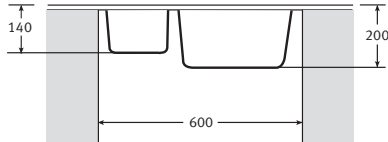

Fixing Clips: Attached

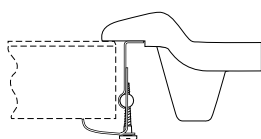

Plumbing Set:

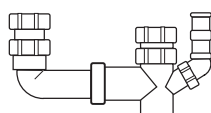

Taps: Any Franke tap can be utilised with this model*.

*Ceramic disc taps in certain installations or where there is a low head of water (below 4 metres) may not provide adequate flow rates. You are advised to check with your supplier.

Guarantee: Franke sinks are guaranteed for 25 years against manufacturing defect. Franke taps are guaranteed against defective materials and workmanship for 1 year in relation to coatings and finishes, and 5 years in relation to moving parts. Franke will replace (and where appropriate repair) defective sinks. In relation to taps, Franke will where appropriate provide replacement parts for your taps or replace your taps. Any associated or ancillary costs to be incurred by you as a result of replacement of Franke sinks and taps under this guarantee shall in all cases be previously approved by Franke UK Limited.

This guarantee is in addition to and does not affect your statutory rights.