

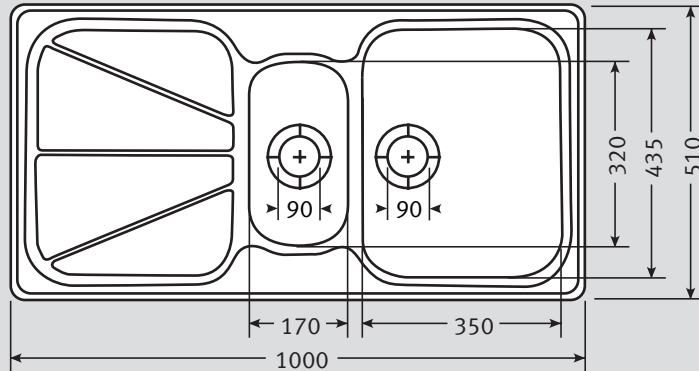







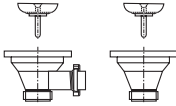

# Simplon SPX 651 Specifications

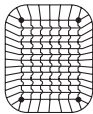
- Stylish Ariane alternative
- Standard Ariane Bowls
- Large diagonal dimensions
- Reversible format
- Wastes in centre of bowls

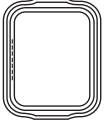

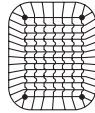
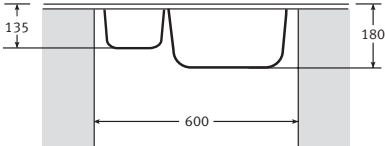
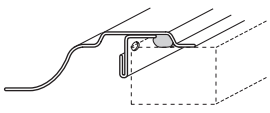
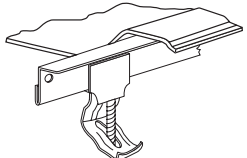
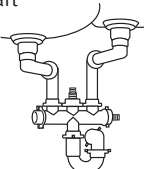
<b>Material:</b>	304 Austenitic 18/10 Stainless Steel	<b>Waste:</b>	1 x Lira 90mm Basket Strainer Waste with overflow 1 x Lira 90mm Basket Strainer Wastes	<b>Overflow:</b>	
<b>Application:</b>	Inset or undermount				
<b>Bowl size:</b>	350 x 435 x 180 170 x 320 x 135				
<b>Drainer Format:</b>	Left or right hand available				
<b>Cut-out size:</b>	984 x 494				
<b>Colour:</b>	Silk Stainless Steel	<b>Accessories available:</b>			
<b>Seal:</b>	Factory fitted Polyurethane seal		<b>Strainer Bowl</b> Available in White, Almond, Brown or Black		<b>Drainer Basket</b> Available in White, Almond, Brown or Black
<b>Insulation:</b>	Grey Dynaphon heat and sound		<b>Drainer Tray</b> Stainless Steel		
<b>Heat Resistance:</b>	Up to 300°C		<b>Drainer Tray</b> Available in White, Almond, Brown or Black		<b>Food Preparation Platter</b> Mahogany
<b>Earthing Point:</b>	Located at end of clip rail		<b>Drainer Basket</b> Stainless Steel		
<b>Cabinet size:</b>					
<b>Sink Profile: Double Edge</b>		<b>Fixing Clips: 'S' rail</b>			
<b>Suggested Plumbing Kit: 2 part</b>					
			<b>Strainer Bowl</b> Stainless Steel		
				<b>Taps:</b> Any Franke tap can be utilised with this model*.	
				*Ceramic disc taps in certain installations or where there is a low head of water (below 4 metres) may not provide adequate flow rates. You are advised to check with your supplier.	
				Some taps may need bracing to avoid flexing of the sink ledge.	

**Guarantee:** Franke sinks are guaranteed for 25 years against manufacturing defect. Franke taps are guaranteed against defective materials and workmanship for 1 year in relation to coatings and finishes, and 5 years in relation to moving parts. Franke will replace (and where appropriate repair) defective sinks. In relation to taps, Franke will where appropriate provide replacement parts for your taps or replace your taps. Any associated or ancillary costs to be incurred by you as a result of replacement of Franke sinks and taps under this guarantee shall in all cases be previously approved by Franke UK Limited. This guarantee is in addition to and does not affect your statutory rights.