

CPX 160 Specifications

- One and a half bowl undermounted configuration
- Large bowls
- Good diagonal dimensions for larger utensils
- 2 x 90mm Wastes with Basket Strainer Wastes. Capable of adaptation to take Waste Disposal Unit

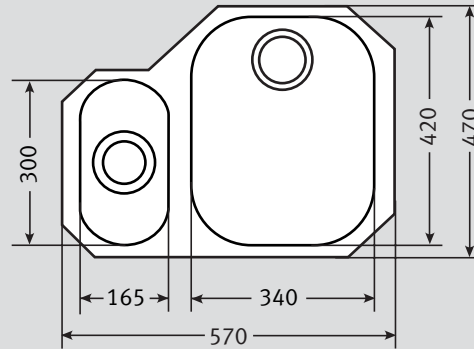

Material: 304 Austenitic 18/10 Stainless Steel

Application: Undermount

Bowl Size: 340 x 420 x 175
165 X 300 X 130

Drainer Format: Not applicable

Cut-out Size: Utilise template

Colour: Silk Stainless Steel

Seal: Apply sealant locally

Insulation: Black Pads

Heat Resistance: Up to 300°C

Earthing Point: Not applicable

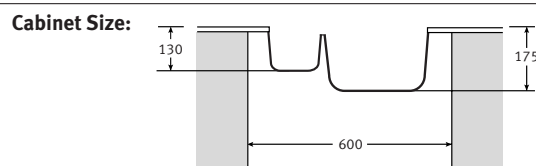

Fixing Clips: Undermount Clips (bag of 6)

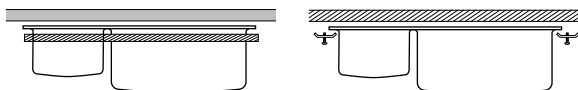

Suggested Plumbing Kit: 2 part

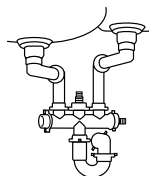

Waste: 1 x Lira 90mm Basket Strainer Waste with overflow
1 x Lira 90mm Basket Strainer Wastes

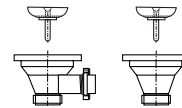

Overflow:

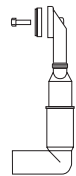

Accessories Available:



Food Preparation Platter
Mahogany



Food Preparation Platter
Hygenia

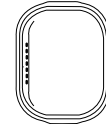

Drainer Tray
Available in White, Almond, Brown or Black

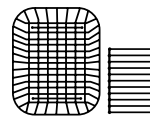

Drainer Basket/Plate Rack
Available in White, Almond, Brown or Black

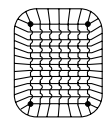

Drainer Basket
Stainless Steel



Strainer Bowl
Available in White, Almond or Brown



Strainer Bowl
Stainless Steel

Taps: Any Franke tap can be utilised with this model*.

*Ceramic disc taps in certain installations or where there is a low head of water (below 4 metres) may not provide adequate flow rates. You are advised to check with your supplier.

Guarantee: Franke sinks are guaranteed for 25 years against manufacturing defect. Franke taps are guaranteed against defective materials and workmanship for 1 year in relation to coatings and finishes, and 5 years in relation to moving parts. Franke will replace (and where appropriate repair) defective sinks. In relation to taps, Franke will where appropriate provide replacement parts for your taps or replace your taps. Any associated or ancillary costs to be incurred by you as a result of replacement of Franke sinks and taps under this guarantee shall in all cases be previously approved by Franke UK Limited.

This guarantee is in addition to and does not affect your statutory rights.