

# GAX 120 Specifications

- Large Infinito style bowls
- Useful three quarter bowl design
- Single cut-out required
- 2 x 90mm Wastes with Basket Strainer Wastes. Capable of adaptation to take Waste Disposal Unit
- Available as MD Menu pack option

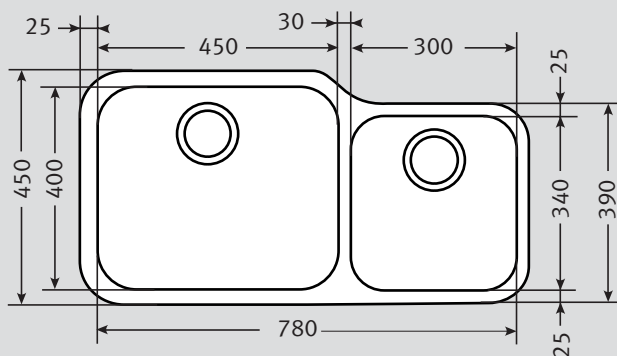

**Material:** 304 Austenitic 18/10 Stainless Steel

**Application:** Undermounted

**Bowl Size:** 450 x 400 x 190  
300 x 340 x 170

**Drainer Format:** Not applicable

**Cut-out Size:** Utilise template

**Colour:** Silk Stainless Steel

**Seal:** Apply sealant locally

**Insulation:** Black Pads for sound insulation

**Heat Resistance:** Up to 300°C

**Earthing Point:** Supplied with sink

**Cabinet Size:**

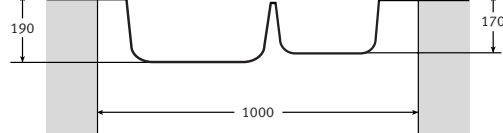

**Fixing Clips:** Provided

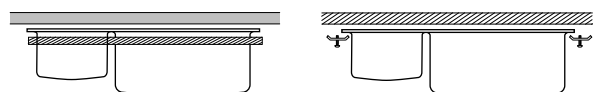

Alternative fixing systems

**Suggested Plumbing Kit:** 2 part

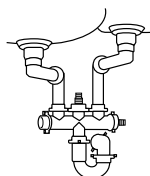

**Waste:** 2 x 90mm Fisc Wastes

**Overflow:**

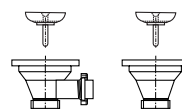

**Accessories Available:**

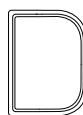

**Food Preparation Platter**  
Mahogany

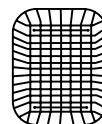

**Drainer Basket**  
Available in White, Almond or Brown

**N.B.** Cut out may not allow for accessories

**Taps:** Any Franke tap can be utilised with this model\*.

\*Ceramic disc taps in certain installations or where there is a low head of water (below 4 metres) may not provide adequate flow rates. You are advised to check with your supplier.

**Guarantee:** Franke sinks are guaranteed for 25 years against manufacturing defect. Franke taps are guaranteed against defective materials and workmanship for 1 year in relation to coatings and finishes, and 5 years in relation to moving parts. Franke will replace (and where appropriate repair) defective sinks. In relation to taps, Franke will where appropriate provide replacement parts for your taps or replace your taps. Any associated or ancillary costs to be incurred by you as a result of replacement of Franke sinks and taps under this guarantee shall in all cases be previously approved by Franke UK Limited.  
This guarantee is in addition to and does not affect your statutory rights.